

Included components

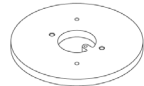

luminaire



Wall mount plate



Wall mount gasket

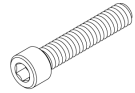

2X – 1/4-20 x 1-1/4"
Socket hd cap screw



2X – 1/4
Lock washer

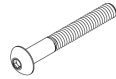

2X – 8-32 x 1-1/4"
Socket button hd cap screw

Tools Required

- Safety glasses
- 5/64", 3/32" and 3/16" hex keys
- Wiring tools and connectors
- Standard octagon junction box, installed (not included)

INSTALLATION PROCEDURE:

Landscape Forms is not responsible for site preparation.

Note: The wall mount plate is designed to work with a standard 4in octagon junction box, supplied by installer. The outside face of the box should be flush or slightly recessed with the wall.

1. Set wall mount gasket over installed junction box. Place wall mount plate over gasket, see Fig. 1. Attach to junction box using two 8-32 x 1-1/4" socket button head cap screws, included. Add silicone if necessary to seal gasket to wall.
2. Remove luminaire dome, see Fig. 2. Back out three set screws to loosen dome. Set aside. Do not fully back out set screws.
3. Position the fixture over the mounting plate. Arrow on cartridge should be facing up. Pull supply wires through opening in cartridge. Secure fixture to wall mount plate using two 1/4-20 1-4" socket head cap screws and lock washers, see Fig.3.
4. Make wiring connections. Connect supply ground to ground screw, see Fig. 4.
5. Reattach dome to fixture. Align set screws with the holes in the cartridge and tighten evenly. Gently lift the dome while threading in the set screws to check for proper engagement of threads.

ASSEMBLE WITH CARE! Pangard II® Polyester Powdercoat is a strong, long-lasting finish. To protect this finish during assembly, place unwrapped powdercoated parts on packaging foam or other non-marring surface. Do not place or slide powdercoated parts on concrete or other hard or textured surface – this will damage the finish causing rust to occur. Use touch-up paint on any gouges in the finish caused by assembly tools.

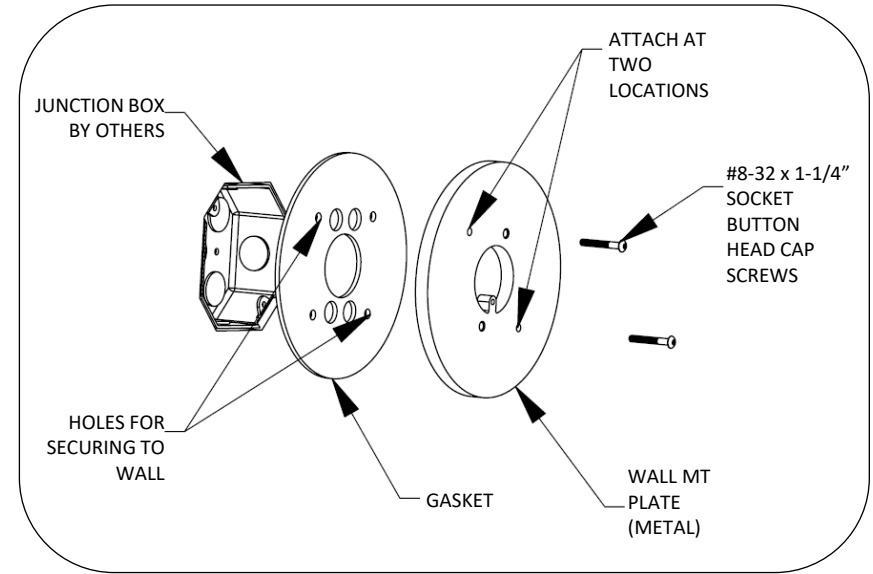

Fig. 1 – secure wall mt plate and gasket to junction box

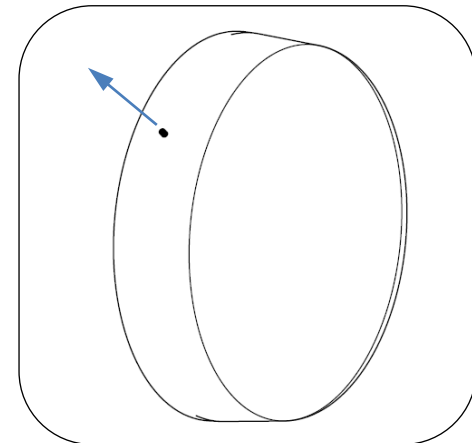

Fig. 2 – back out set screws

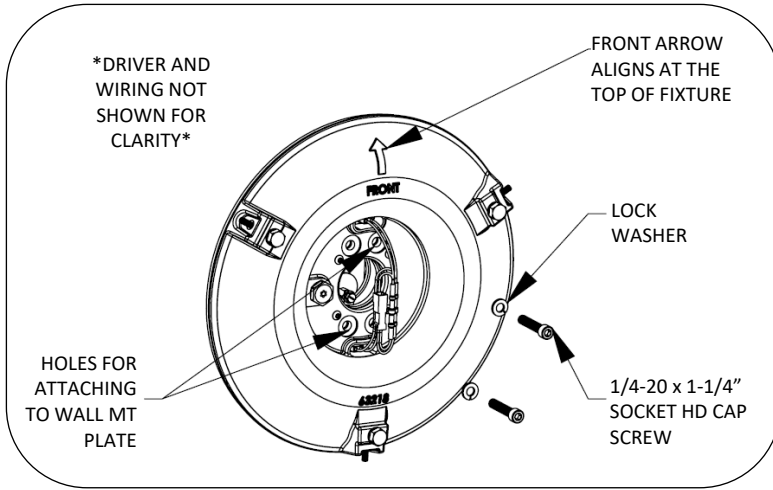

Fig. 3 – secure cartridge to wall mt plate

PROCEDURE FOR WIRING:

The Motive wall mount luminaire is assembled at the factory. The light cartridge is mounted into the body of the luminaire and will not need to be removed during installation. The LED cartridge is wired to the driver at the factory. Use of LED drivers other than the supplied unit is not recommended and will void the warranty.

Connection hardware not included.

Installers are responsible for line-in connections.

Optional dimming control is not included.

WARNING!: LED cartridge and driver are not rated for connection or disconnection while energized. Doing so may damage LEDs and will void the warranty. Disconnect incoming power before making or breaking any electrical connections.

Note: This unit is pre-wired.

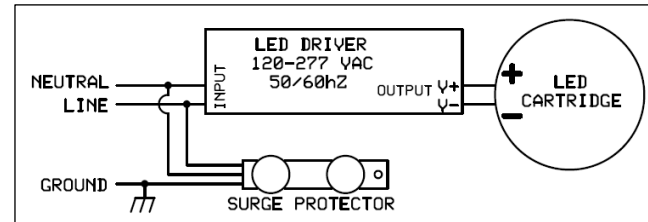

Fig. 4 – wiring diagram