

Metro40 Collection

landscapeforms

Product Data Sheet



When Landscape Forms set out to develop the first comprehensive and integrated collection of site elements for the streetscape and transit core, it partnered with a world-leading expert. BMW Group Designworks brought to the challenge a deep understanding of the role of public transit in the life of the city, and unsurpassed mastery in form making and innovative use of materials. The Metro40 Collection, from benches and bollards to bus shelters and LED lighting, is a pioneering line of urban streetscape and transit elements with sophistication and global appeal for a world on the move. Used with Connect shelter or alone where space is at a premium, sitting and leaning rails provide a 'waiting room' amenity with minimal footprint.

Rest™ Bench



- Rest length is 80", longer than typical three-person benches.
- Rest seat height is 18" and seat depth is 16".
- Optional arms (available only on backed version)
- End frames are joined using concealed mortise and tenon connections.
- Available with one or two optional intermediate cast aluminum seat dividers/skateboard deterrents.
- Equipped with "anti-glides:" cushioned plastic pads on the underside of the frame that keep the bench from moving under seated loads and protect the powdercoat finish from becoming scratched by concrete or floor.

Materials

- End frame is cast aluminum.
- Seat and back slats are aluminum extrusions or wood.
- Cast aluminum frame and aluminum extrusion slats are powder-coated.
- Aluminum version can be two-toned: one color on the continuous ribbon end frame and another color on the slats.
- The wood for exterior applications is jarrah.
- The wood option for interior application is jarrah with LF 80 finish.

Installation

- Shipped fully assembled.
- Freestanding, surface mount or embedded.
- Surface mount and embedded versions are shipped with a mounting kit.

	Style	Depth	Width	Height	Product Weight
	backed w/ arm	26 1/2"	80"	33 1/2"	Jarrah: 135 lb Alum: 167 lb
	backed w/o arms	26 1/2"	80"	33 1/2"	Jarrah: 125 lb Alum: 157 lb
	backless	20 3/4"	80"	18"	Jarrah: 91 lb Alum: 106 lb

Note: The backless version is always armless.
Seat dividers cannot be used at ends as a substitute for arms.

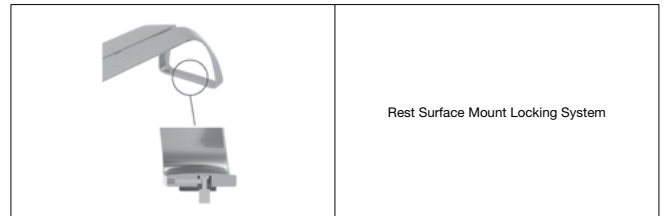

Rest Surface Mount Locking System

Metro40 Collection

landscapeforms

Product Data Sheet







Connect Rail

- Connect Rail is available as a sitting rail or a leaning rail.
- Rail ships fully assembled.
- Rail must be surface mounted.
- Aluminum option is a cast aluminum frame with an aluminum extrusion insert.
- Wood option is a cast aluminum frame with a wood insert.

Finishes

- Metal is finished with Landscape Forms' proprietary Pangard II® polyester powdercoat, a hard yet flexible finish that resists rusting, chipping, peeling and fading.
- Call for standard color chart.
- Unfinished jarrah and DSTMA for exterior use.

	Style	Depth	Width	Height	Product Weight
	Sitting Rail	7"	45"	18"	Aluminum 46 lb
	Sitting Rail	7"	45"	18"	Wood 43 lb
	Leaning Rail	6.5"	45"	30"	Aluminum 51 lb
	Leaning Rail	6.5"	45"	30"	Wood 54 lb

Metro40 Collection

landscapeforms

Product Data Sheet



Collect™ Litter

- All Collect receptacles have a cast aluminum frame and rotationally-molded polyethylene bin.

Top-opening

- 30-gallon capacity.
- Freestanding or surface mount.
- Freestanding version has a cast iron base.
- Bin pivots open for emptying; bag is pulled out at a 35° angle.
- Bag is attached by clips to inside of molded bin.
- No diverter rim.
- Molded bin color comes standard in matte black; optional polyethylenecolors available.
- Side latch with optional keyed lock.

Side-opening

- 23-gallon capacity.
- Open on two sides for easy trash toss.
- Freestanding or surface mount.
- Freestanding version has a cast iron base.
- Bin pivots open for emptying; bag is pulled out at a 35° angle.
- Bag is attached by clips to inside of molded bin.
- Spun-steel diverter around top opening directs trash; diverter is connected to the ribbon frame and diverter is powdercoated matte black color to coordinate with the standard black bin. If an optional bin color is selected than the diverter is powdercoated to match the frame.

Collect Recycling Receptacles

- 30-gallon capacity.
- Freestanding or surface mount.
- Freestanding version has a cast iron base.
- Bin pivots open for emptying; bags are pulled out at a 35° angle.
- Bags attached by clips to inside of molded bin.
- Side latch with optional keyed lock.
- Visit landscapeforms.com for signage options.

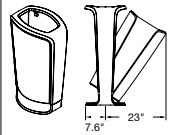
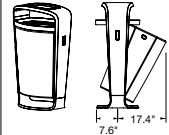
	Style	Depth	Width	Height	Product Weight
	30-gallon top-opening freestanding litter	15.9"	23.5"	37.9"	140 lb
	23-gallon side-opening freestanding litter	15.9"	23.5"	37.9"	145 lb

Collect Recycling Hole and Slot Tops		
		
30-Gallon Recycle Receptacle with Hole	30-Gallon Recycle Receptacle with Slot	30-Gallon Recycle Receptacle with Multi Use

Metro40 Collection

landscapeforms

Product Data Sheet



Latch/Lock Location and Operation

- Latch is located on the side of the receptacle, within the ribbon.
- When lockless, the latch is simply pushed to release the bin; bin is pushed back into place to automatically catch.
- When locked, a key is used to free the latch before operation.
- The lock is self-contained and can be retrofitted.

Collect Latch/Lock Mechanism



Collect Latch/Lock Mechanism



Metro40 Collection

landscapeforms

Product Data Sheet



Stop™ Bollard

- Sleeve is cast aluminum with an integral ring at the base.
- Aesthetically all mounting options look the same.
- Post is 4" structural steel pipe.
- Post is 28" high; the total height of the bollard from ground to top of aluminum casting is 34".
- Base plate on surface-mounted bollard is stainless steel.
- All exterior parts are powdercoated.
- Sleeve can be powdercoated in a selection of colors.
- Post is standard matte black.

Mounting Options

- Stop may be embedded, surface mount or removable.

Embedded



- This is the strongest and most common method for installation.
- The steel post is set into an 18" concrete footing.
- The steel post is slipped over the top of the post and locked into the base of the post with tamper-resistant set screws.
- A stainless steel ring helps align and aid installation.

Surface Mount

- The steel post on all surface mount versions aesthetically matches the embedded version but allows for more installations on existing sites.
- A stainless steel base plate welded to the steel pipe is anchored to the concrete in three locations.
- The stainless steel base plate helps align and aid installation.
- 3 stainless steel leveling glides allow installation to be perfectly "dialed-in" from the top side of base.
- The cast aluminum sleeve with integral base ring is slipped over the top and locked into the base of the post with tamper-resistant set screws.

Removable

- The removable version aesthetically matches embedded and surface mount versions.
- A galvanized socket is embedded in concrete.
- The steel post is inserted into the socket, and secured with locking mechanism.
- The cast aluminum sleeve with integral base ring is slipped over the top of the post and locked into the base of the post with tamper-resistant set screws.

	Style	Depth	Width	Height	Product Weight
	Surface Mount Bollard	19"	7"	34"	63 lb
	Embedded Bollard	19"	7"	34"	75 lb
	Removable Bollard <i>(not available with integral light)</i>	19"	7"	34"	95 lb

	Embedded, Surface Mount or Removable Bollard		Embedded or Surface Mount Bollard with LED Light
---	--	---	--

Metro40 Collection

landscapeforms

Product Data Sheet



To Remove Bollard

- Using key, turn locking mechanism to release post.
- Remove sleeve and post together by lifting up and out.
- Post and sleeve can be removed separately if preferred.

Note: Unlike some other removable bollards, Stop enables the post and sleeve to be removed as a single unit by one person. (Post and sleeve together weight approximately 60 lbs.) Care should be taken to set the sleeve in a place where it will be protected from damage while not in use.

LED Lighting

- An optional wired LED light is available on both embedded and surface-mounted versions.
- The light must be connected to the grid.

Features and Installation

- The bollard light is designed for wayfinding applications, the process for guiding, directing and signaling people through space.
- The light is mounted in the top of the bollard post.
- Light shines upward from the fixture, illuminating the inside surface of the sleeve and filling the space between the top of the post and the underside of the ribbon.
- The soft ambient glow from the LED light does not project light onto the ground or pathway.
- The light cap employs the same Acrylite® lens technology as Hi-Glo and Lo-Glo lights.
- To install, bring conduit up through the concrete into the bollard post.
- 60,000 hour LED rated life.
- Power consumption is approximately 3 watts.
- Lumen output is approximately 50 lumens.
- Warm-white LED color temperature of 3500K.

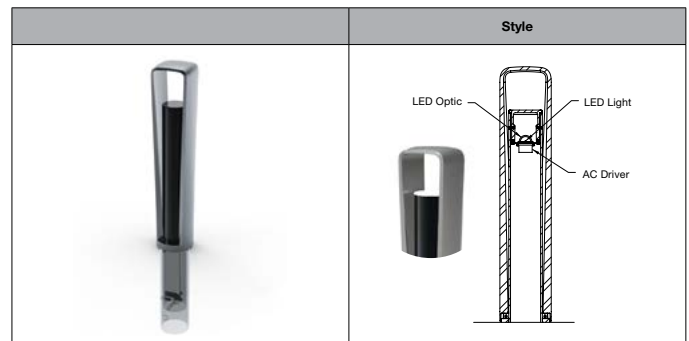

Metro40 Collection

landscapeforms

Product Data Sheet



Ride™ Bike Rack

- Capacity: 2 bikes
- Surface mount or embedded to concrete surface.
- Requires only two bolts to mount, with extra surface mount anchor hole provided.
- 4 stainless steel leveling glides within the base are provided for fine adjustment from top side of base.
- Cover plate over bike rack base provides seamless appearance.

Hi-Glo™ Pedestrian Light and Lo-Glo™ Path Light

- Please refer to product data sheets for technical information and specifications.

Connect 2.0

- Please refer to the product data sheet for technical information and specifications.

To Specify

- Visit landscapeforms.com.

Designed by BMW Group Designworks

[Click here](#) for patent information related to this product.

	Style	Depth	Width	Height	Product Weight
	Bike Rack	3.3"	28"	26"	50 lb

Visit landscapeforms.com for more information. Specifications are subject to change without notice. Landscape Forms supports the Landscape Architecture Foundation at the Second Century level.
©2024 Landscape Forms, Inc. Printed in U.S.A.