

Freestanding

Surface Mount

Wall Mount

### Included components



1x – All units



2x – All units

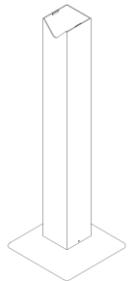

1x – Freestanding  
1x – Surface Mount

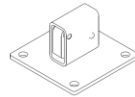

1x – Surface Mount



1x – Wall Mount

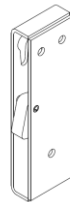

1x – Wall Mount

### Tools Required

- Safety glasses
- For Surface Mount Unit: (4) Non-corrosive anchors required per unit (not included). See Figure 1 for recommended size.
- For Wall Mount Unit: (3) Non-corrosive anchors required per unit (not included). See Figure 2 for recommended size.
- Appropriate drill and bits based on anchors selected and anchoring surface.

### To empty unit:

1. Remove top casting.
2. For surface mount or wall mount units, base must also be released from anchor brackets.
3. Tip base upside down to empty.

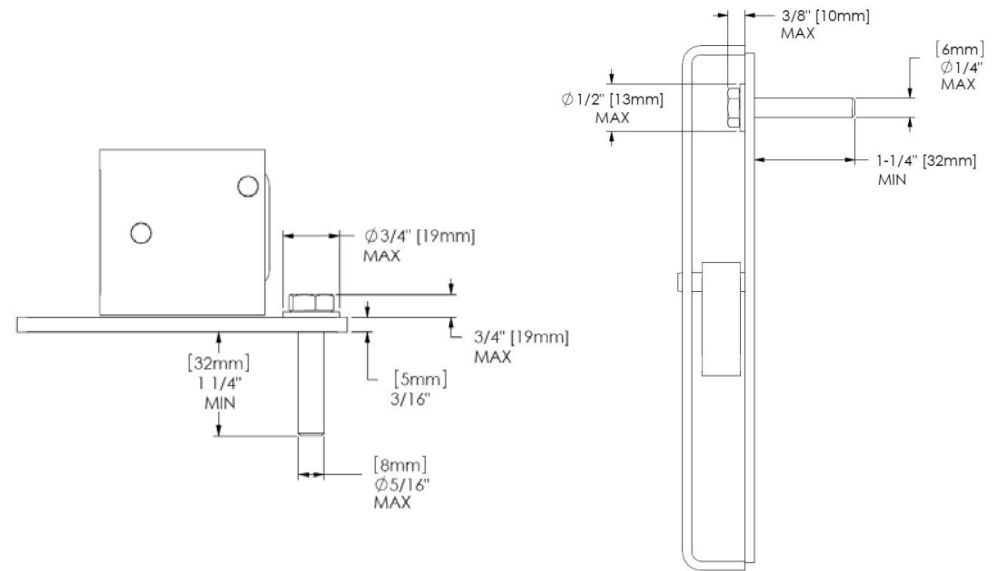
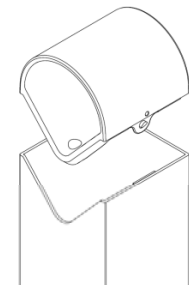
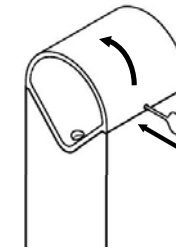

Figure 1 – Surface mount anchor size

Figure 2 – Wall mount anchor size



Install top casting



Remove top casting

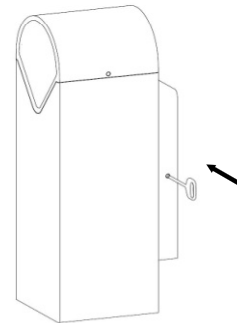

Remove wall mount base

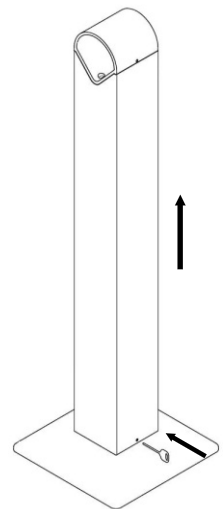
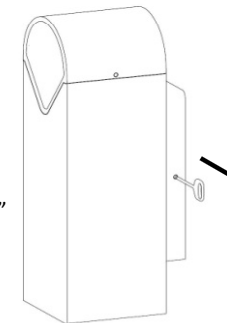

Remove surface mount base

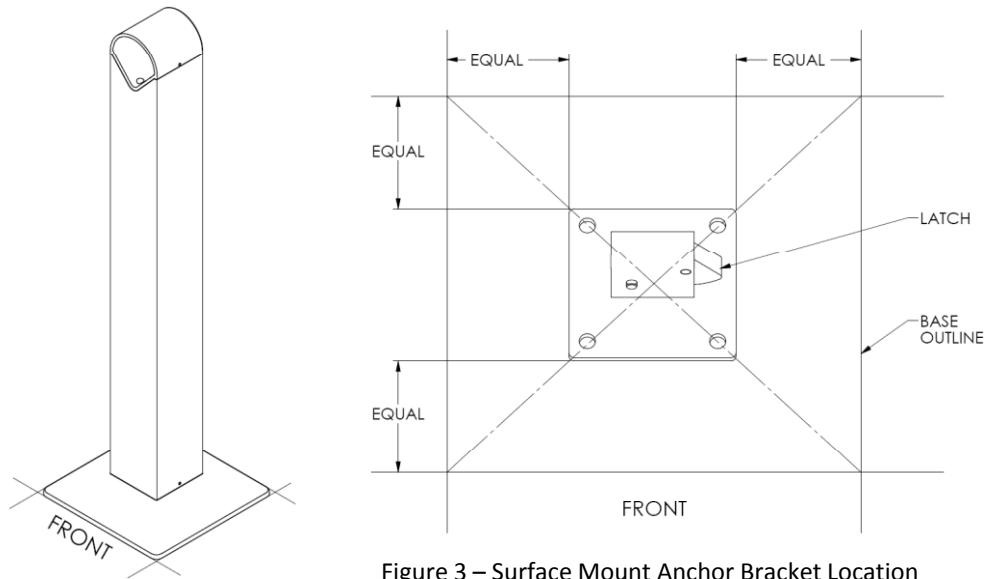

Figure 3 – Surface Mount Anchor Bracket Location

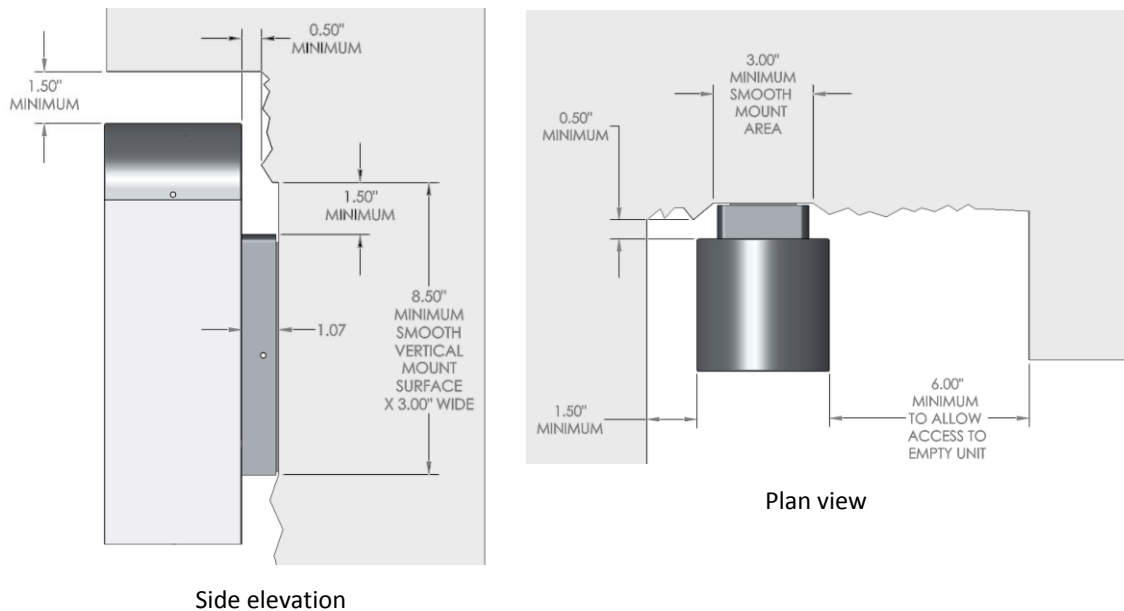

Figure 4 – Wall Mount Guidelines

### INSTALLATION PROCEDURE FOR A FREESTANDING UNIT:

1. Install top casting onto base unit and set in place.

### INSTALLATION PROCEDURE FOR A SURFACE MOUNTED UNIT:

1. Install top casting onto base unit and set in place.
2. Trace the outline of the base, indicating which side has the opening.
3. Move the unit and locate the surface mount plate assembly in the center of the outline. The plastic latch should be located 90° counterclockwise from the side marked 'opening'.
4. Mark the hole locations
5. Move the surface mount plate to allow access for drilling the holes.
6. Install the anchors and surface mount plate according to anchor manufacturer's instructions.
7. Place unit over surface mount plate, ensuring latch has engaged.

### INSTALLATION PROCEDURE FOR A WALL MOUNTED UNIT:

1. Install top casting onto base unit and set in place.
2. Trace the outline of the wall mount housing.
3. Move the unit and locate the wall mount bracket as shown in Figure 5. Mark the hole locations
4. Move the wall mount bracket to allow access for drilling the holes.
5. Install the anchors and wall mount bracket according to anchor manufacturer's instructions.
6. Attach the unit by aligning the studs to the keyholes in the mount bracket. Push the unit horizontally back until it contacts the mount plate firmly, then lower the unit on the studs until it locks into position.

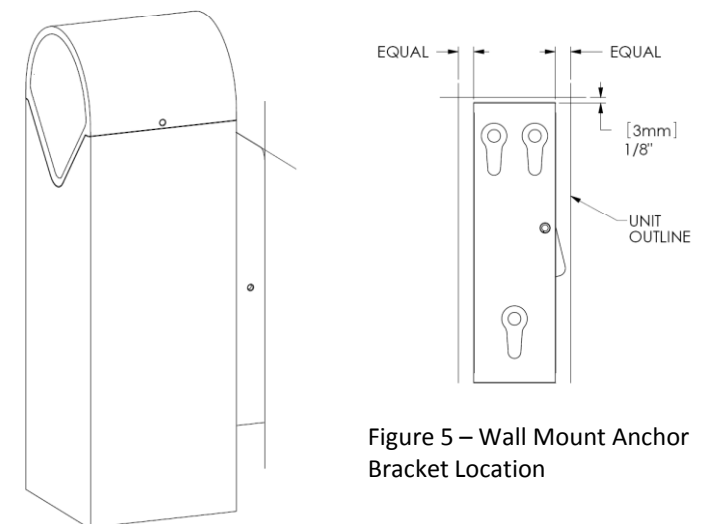

Figure 5 – Wall Mount Anchor Bracket Location